

SOT-89-3L Plastic-Encapsulate Voltage Regulators

CJ78L05 Three-terminal positive voltage regulator

FEATURES

- Maximum output current
 $I_{OM}: 0.1A$
- Output voltage
 $V_O: 5V$
- Continuous total dissipation
 $P_D: 0.6 W (T_a= 25 ^\circ C)$

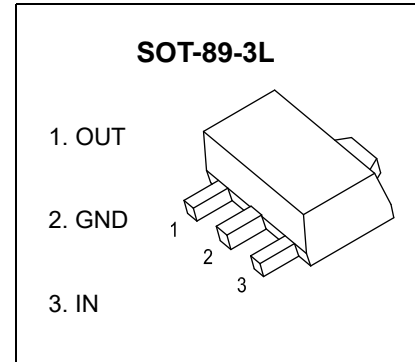

ABSOLUTE MAXIMUM RATINGS (Operating temperature range applies unless otherwise specified)

Parameter	Symbol	Value	Unit
Input Voltage	V_i	30	V
Thermal Resistance from Junction to Ambient	$R_{\theta JA}$	160	$^\circ C/W$
Operating Junction Temperature Range	T_{OPR}	-40~+125	$^\circ C$
Storage Temperature Range	T_{STG}	-65~+150	$^\circ C$

ELECTRICAL CHARACTERISTICS AT SPECIFIED VIRTUAL JUNCTION TEMPERATURE ($V_i=10V, I_o=40mA, C_i=0.33\mu F, C_o=0.1\mu F$, unless otherwise specified)

Parameter	Symbol	Test conditions	Min	Typ	Max	Unit
Output voltage	V_o	$T_J=25^\circ C$	4.85	5.0	5.15	V
			4.90	5.0	5.10	V
		$7V \leq V_i \leq 20V, I_o=1mA \sim 40mA$	4.75	5.0	5.25	V
			$I_o=1mA \sim 70mA$	4.75	5.0	5.25
Load Regulation	ΔV_o	$I_o=1mA \sim 100mA, T_J=25^\circ C$		15	60	mV
		$I_o=1mA \sim 40mA, T_J=25^\circ C$		8	30	mV
Line regulation	ΔV_o	$7V \leq V_i \leq 20V$		32	150	mV
		$8V \leq V_i \leq 20V, T_J=25^\circ C$		26	100	mV
Quiescent Current	I_q	$T_J=25^\circ C$		3.8	6	mA
Quiescent Current Change	ΔI_q	$8V \leq V_i \leq 20V$			1.5	mA
	ΔI_q	$1mA \leq V_i \leq 40mA$			0.1	
Output Noise Voltage	V_N	$10Hz \leq f \leq 100KHz, T_J=25^\circ C$		42		$\mu V/V_o$
Ripple Rejection	RR	$8V \leq V_i \leq 20V, f=120Hz$	41	49		dB
Dropout Voltage	V_d	$T_J=25^\circ C$		1.7		V

* Pulse test.

TYPICAL APPLICATION

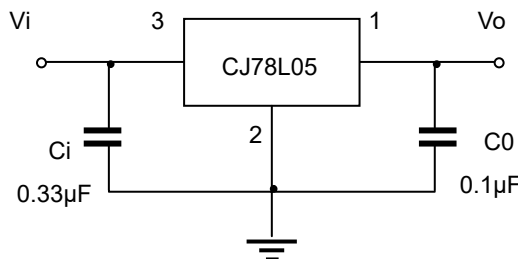

Note1: Bypass capacitors are recommended for optimum stability and transient response and should be located as close as possible to the regulators.

Note2: This IC may be damaged by ESD. Relevant personnel shall comply with correct installation and use specifications to avoid ESD damage to the IC. Adding a suitable resistor in front of the IC input can reduce the possibility of IC damage by ESD to a certain extent.

Typical Characteristics

Output Characteristics

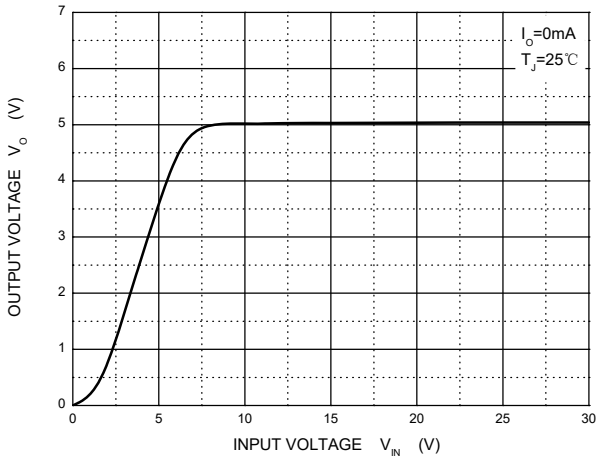

Dropout Characteristics

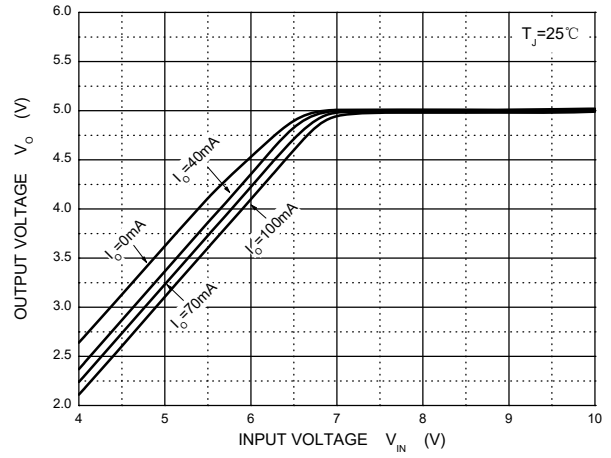

Quiescent Current vs Input Voltage

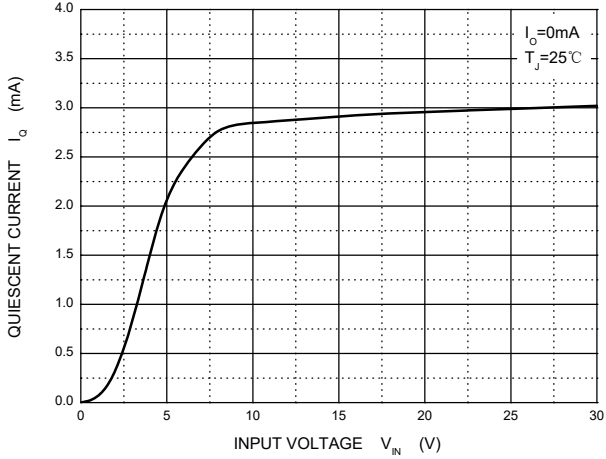

Current Cut-off Grid Voltage

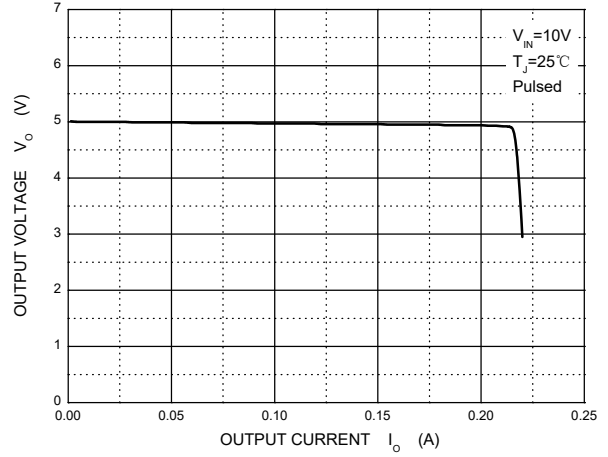

Output Voltage vs Junction Temperature

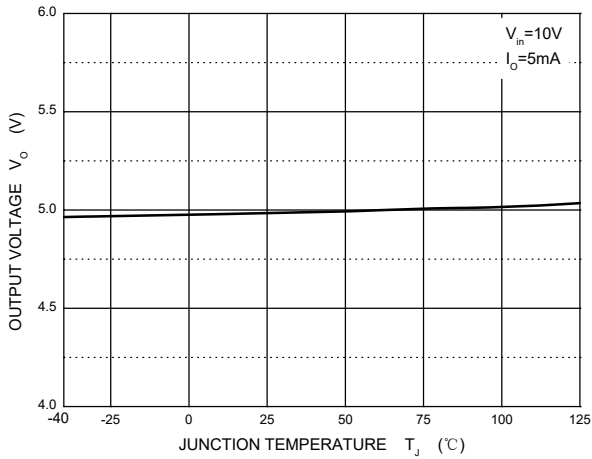

Power Derating Curve

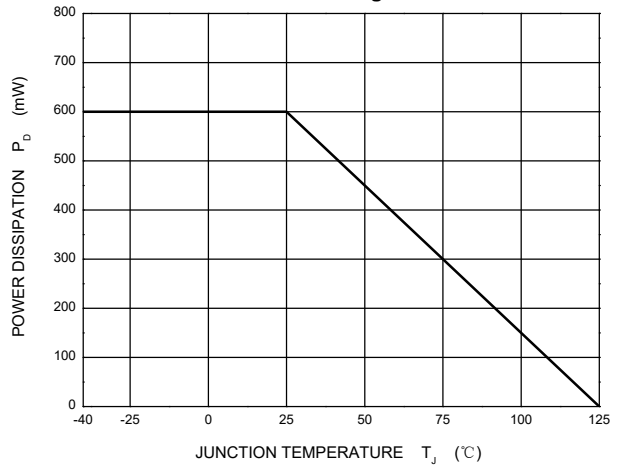

SOT-89-3L Package Outline Dimensions

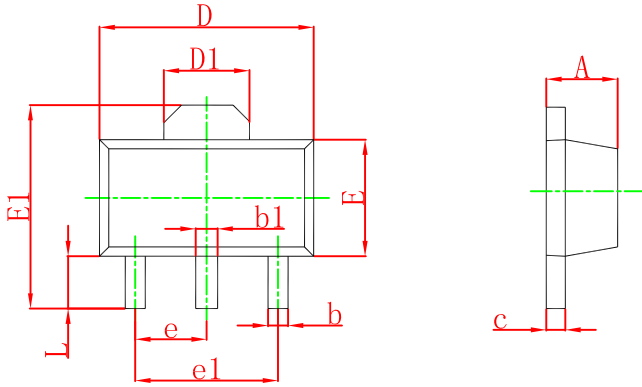

Symbol	Dimensions In Millimeters		Dimensions In Inches	
	Min	Max	Min	Max
A	1.400	1.600	0.055	0.063
b	0.320	0.520	0.013	0.020
b1	0.400	0.580	0.016	0.023
c	0.350	0.440	0.014	0.017
D	4.400	4.600	0.173	0.181
D1	1.550 REF.		0.061 REF.	
E	2.300	2.600	0.091	0.102
E1	3.940	4.250	0.155	0.167
e	1.500 TYP.		0.060 TYP.	
e1	3.000 TYP.		0.118 TYP.	
L	0.900	1.200	0.035	0.047

SOT-89-3L Suggested Pad Layout

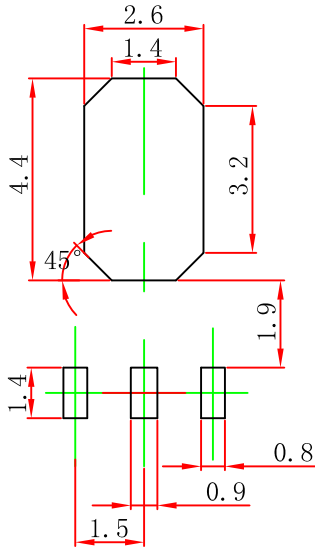

Note:

1. Controlling dimension: in millimeters.
2. General tolerance: ± 0.05 mm.
3. The pad layout is for reference purposes only.

SOT-89-3L Tape and Reel

SOT-89-3L Embossed Carrier Tape

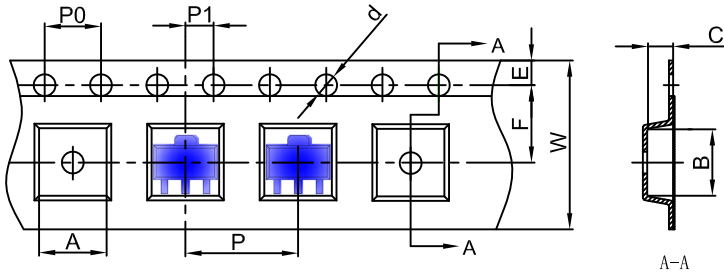

Packaging Description:

SOT-89-3L parts are shipped in tape. The carrier tape is made from a dissipative (carbon filled) polycarbonate resin. The cover tape is a multilayer film (Heat Activated Adhesive in nature) primarily composed of polyester film, adhesive layer, sealant, and anti-static sprayed agent. These reeled parts in standard option are shipped with 1,000 units per 7" or 18.0 cm diameter reel. The reels are clear in color and is made of polystyrene plastic (anti-static coated).

Dimensions are in millimeter										
Pkg type	A	B	C	d	E	F	P0	P	P1	W
SOT-89-3L	4.85	4.45	1.85	Ø1.50	1.75	5.50	4.00	8.00	2.00	12.00

SOT-89-3L Tape Leader and Trailer

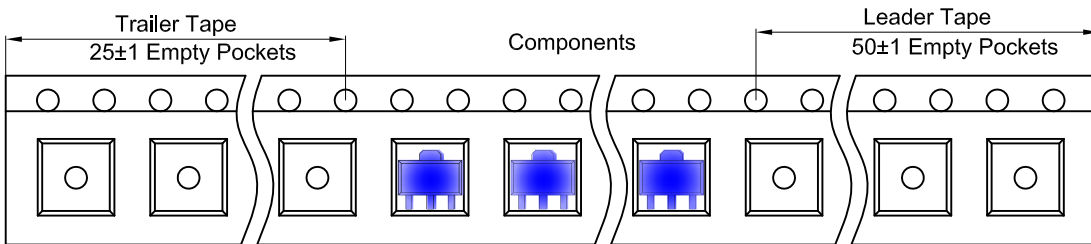

SOT-89-3L Reel

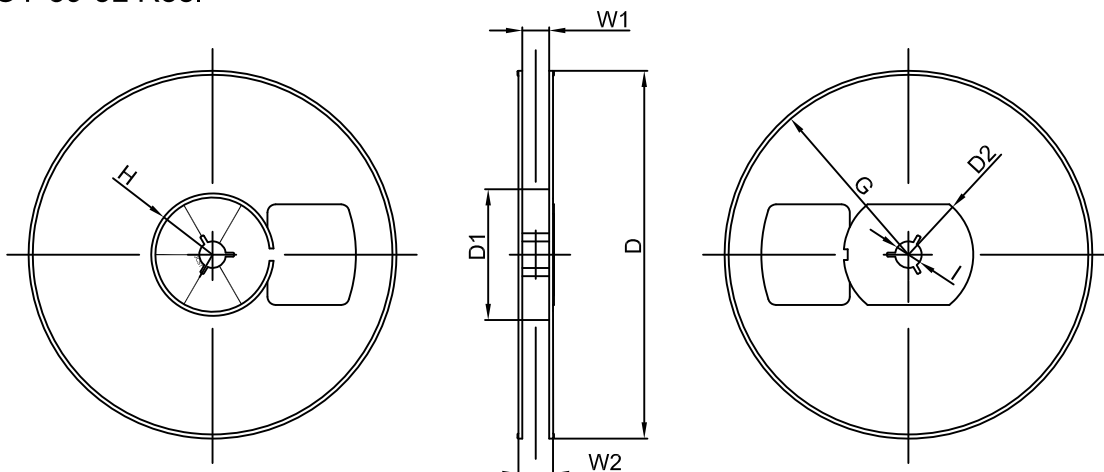

Dimensions are in millimeter								
Reel Option	D	D1	D2	G	H	I	W1	W2
7" Dia	Ø180.00	60.00	R32.00	R86.50	R30.00	Ø13.00	13.20	16.50

REEL	Reel Size	Box	Box Size(mm)	Carton	Carton Size(mm)	G.W.(kg)
1000 pcs	7 inch	10,000 pcs	203×203×195	40,000 pcs	438×438×220	

DISCLAIMER

IMPORTANT NOTICE, PLEASE READ CAREFULLY

The information in this data sheet is intended to describe the operation and characteristics of our products. JSCJ has the right to make any modification, enhancement, improvement, correction or other changes to any content in this data sheet, including but not limited to specification parameters, circuit design and application information, without prior notice.

Any person who purchases or uses JSCJ products for design shall: 1. Select products suitable for circuit application and design; 2. Design, verify and test the rationality of circuit design; 3. Procedures to ensure that the design complies with relevant laws and regulations and the requirements of such laws and regulations. JSCJ makes no warranty or representation as to the accuracy or completeness of the information contained in this data sheet and assumes no responsibility for the application or use of any of the products described in this data sheet.

Without the written consent of JSCJ, this product shall not be used in occasions requiring high quality or high reliability, including but not limited to the following occasions: medical equipment, automotive electronics, military facilities and aerospace. JSCJ shall not be responsible for casualties or property losses caused by abnormal use or application of this product.

Official Website: www.jscj-elec.com

Copyright © JIANGSU CHANGJING ELECTRONICS TECHNOLOGY CO., LTD.